

DS-2DE7232IW-AE

2 MP Outdoor 32× IR Network Speed Dome



- **1/2.8" Progressive Scan CMOS**
- **Up to 1920 x 1080 Resolution**
- **Minimum Illumination:**
Color: 0.005 Lux @ (f/1.6, AGC on)
B/W: 0.001 Lux @ (f/1.6, AGC on)
0 Lux with IR
- **Up to 490 ft (150 m) IR Distance**
- **H.265+/H.265 Video Compression**
- **32x Optical Zoom, 16x Digital Zoom**
- **Electronic Image Stabilization**
- **Smart Tracking, EIS, Defog**
- **120 dB WDR**
- **Smart Detection: Line Crossing, Intrusion, Region Enter/Exit**
- **IP66 Protection**
- **24 VAC and Hi-PoE (maximum 40 W)**

Hikvision DS-2DE7232IW-AE Network IR Speed Dome Cameras produce images with a resolution of up to 1920 x 1080 pixels.

The embedded 1/2.8" progressive scan CMOS chip supports 120 dB WDR, and the 32x optical zoom allows for greater detail to be collected over more expansive areas.

The Network IR Speed Dome Camera also features a wide range of smart functions, including intrusion detection, and line crossing detection, which allows for key events and objects to be recorded for further forensic needs.

The camera features Electronic Image Stabilization (EIS), an image enhancement technique that reduces blurring and provides compensation in adverse environmental conditions.







Available models:
DS-2DE7232IW-AE

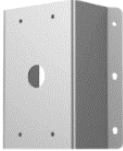

Specifications

DS-2DE7232IW-AE	
Camera Module	
Image Sensor	1/2.8" progressive scan CMOS
Minimum Illumination	Color: 0.005 lux @ (f/1.6, AGC on); B/W: 0.001 lux @ (f/1.6, AGC on), 0 lux with IR
Shutter Speed	1/1 to 1/30,000 s
White Balance	Auto/manual/ATW (auto-tracking white balance)/indoor/outdoor/fluorescent lamp/sodium lamp
AGC	Auto/manual
Day/Night	IR cut filter
Digital Zoom	16x
Privacy Mask	24 programmable privacy masks
Focus Mode	Auto/semi-automatic/manual
Digital WDR	120 dB
Lens	
Focal Length	4.8 mm to 153 mm, 32x optical
Zoom Speed	Approximately 5.6 s (optical lens, wide to tele)
Angle of View	Horizontal field of view: 55.6° to 2.04° (wide to tele); vertical field of view: 32.4° to 1.14° (wide to tele); diagonal field of view: 63° to 2.34° (wide to tele)
Minimum Working Distance	10 mm to 1,500 mm (wide to tele)
Aperture Range	f/1.2 to f/4.4
IR	
IR Distance	Up to 490 ft (150 m)
Smart IR	Supported
PTZ	
Movement Range (Pan)	360° endless
Pan Speed	Configurable, from 0.1°/s to 160°/s, preset speed: 240°/s
Movement Range (Tilt)	From -15° to 90°
Tilt Speed	Configurable, from 0.1°/s to 120°/s, preset speed: 200°/s
Proportional Zoom	Supported
Presets	300
Patrol Scan	8 patrols, up to 32 presets for each patrol
Pattern Scan	4 pattern scans, record time over 10 minutes for each scan
Power-off Memory	Supported
Park Action	Preset/pattern scan/patrol scan/auto scan/tilt scan/random scan/frame scan/panorama scan
3D Positioning	Supported
PTZ Status Display	On/off
Preset Freezing	Supported
Scheduled Task	Preset/pattern scan/patrol scan/auto scan/tilt scan/random scan/frame scan/panorama scan/dome reboot/dome adjust/aux output
Compression Standard	
Video Compression	Main stream: H.265+/H.265/H.264+/H.264; sub-stream: H.265/H.264/MJPEG; third stream: H.265/H.264/MJPEG
H.264 Type	Baseline profile/main profile/high profile
H.264+	Supported
H.265 Type	Baseline profile/main profile/high profile
H.265+	Supported
Video Bitrate	32 kbps to 16,384 kbps
Audio Compression	G.711 alaw/G.711 ulaw/G.722.1/G.726/MP2L2/PCM
Audio Bitrate	G.711 alaw/G.711 ulaw: 64 Kbps; G.722.1/G.726: 16 Kbps; MP2L2/PCM: 32 Kbps/64 Kbps/128 Kbps
SVC	Supported
Smart Features	
Basic Event	Motion detection, alarm input, alarm output, video tampering detection, exception
Smart Event	Intrusion detection, line crossing detection, region entrance detection, region exiting detection, object removal detection, unattended baggage detection
Smart Record	ANR (Automatic Network Replenishment), Dual-VCA
ROI	Main stream, sub-stream, and third stream respectively supports four fixed areas
Auto Tracking	Supported
Image	
Maximum Resolution	1920 × 1080
Main Stream	30 fps (1920 × 1080, 1280 × 960, 1280 × 720), 60 fps (1920 × 1080, 1280 × 960, 1280 × 720)
Sub-Stream	30 fps (704 × 480, 640 × 480, 352 × 240)
Third Stream	30 fps (1920 × 1080, 1280 × 960, 1280 × 720, 704 × 480, 640 × 480, 352 × 240)
Image Enhancement	HLC/BLC/3D DNR/Defog/EIS/Regional Exposure/Regional Focus
Network	
Network Storage	Built-in memory card slot, supports microSD/SDHC/SDXC, up to 256 GB; NAS (NFS, SMB/CIFS), ANR
Alarm Linkage	Alarm actions such as preset, patrol scan, pattern scan, memory card video record, trigger recording, notify surveillance center, upload to FTP/memory card/NAS, send e-mail, etc.
Protocols	IPv4/IPv6, HTTP, HTTPS, 802.1x, QoS, FTP, SMTP, UPnP, SNMP, DNS, DDNS, NTP, RTSP, RTCP, RTP, TCP/IP, DHCP, PPPoE, Bonjour
API	Open-ended, supports ONVIF, CGI, HIKVISION SDK, and third-party management platforms
Simultaneous Live View	Up to 20 channels
User/Host	Up to 32 users; 3 levels: administrator, operator, and user
Security Measures	User authentication (ID and PW), host authentication (MAC address); HTTPS encryption; IEEE 802.1x port-based network access control; IP address filtering
Client	iVMS-4200, iVMS-4500, Hik-Connect
Web Browser	IE 8 to 11, Chrome 31.0 to 44, Firefox 30.0 to 51
Interface	
Alarm Interface	2-ch alarm input and 1-ch alarm output
Audio Interface	1-ch audio input and 1-ch audio output
Network Interface	1 RJ-45 10 M/100 M Ethernet Interface, Hi-PoE
General	
Power	24 VAC (maximum 40 W); Hi-PoE (maximum 14 W for IR)
Working Temperature	-22° to 149° F [-30° to 65° C]; humidity: ≤90% non-condensing
Protection Level	IP66 standard, TVS 6000V lightning protection, surge protection, and voltage transient protection
Material	ADC 12, PC, PC + 10% GF
Dimensions	Ø8.66" × 13.91" (Ø220 mm × 353.4 mm)
Weight	Approximately 9.92 lb (4.5 kg)

Accessories

NOT INCLUDED							INCLUDED
							
JBPW-L Power Box Mount w/Wall Bracket	CMP-JB Corner Mount for JBPW-L	PMP-JB Pole Mount for JBPW-L	CPM-S Short Ceiling Pendant Mount	CPM-L Long Ceiling Pendant Mount	CPMPE CPM Extension Pipe	RPM Roof Parapet Mount	(actual product appearance may vary) G1.5 Adapter Converts Hikvision Quick Release To G 1.5" Thread

Dimensions

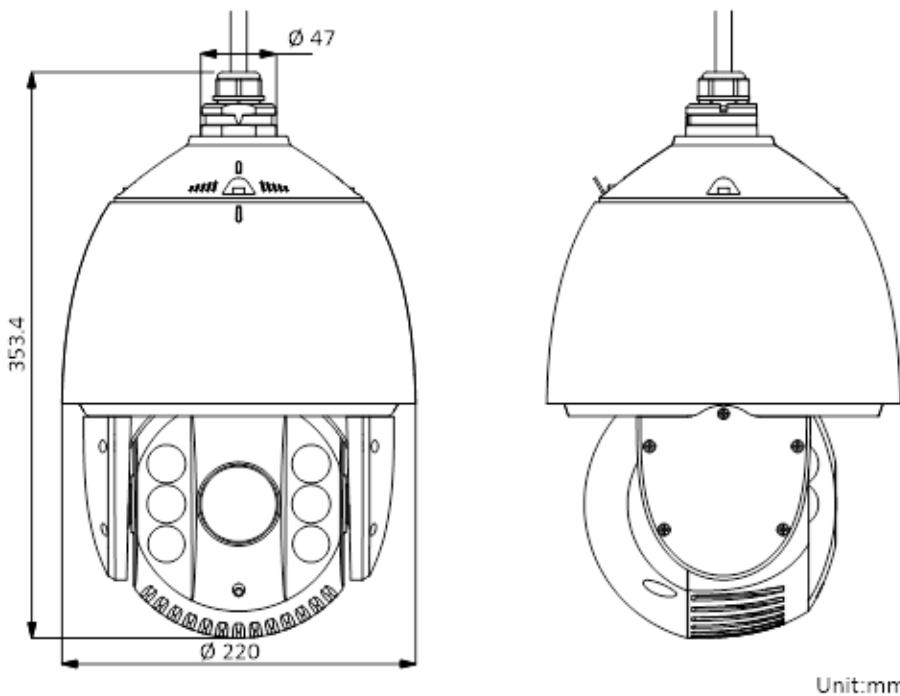

Box Contents (Subject To Change without Notice)

PoE Injector
 Power Cord
 Quick Start Guide
 Quick Release to 1.5" Adapter
 Watertight Cable Connector
 Wrench